

# Linear System Configurations

“The Linear System Series places people at its center, being a place to meet, to collaborate or to work in focused solitude. The design process was about creating a system that made for intimately welcoming atmospheres, enhanced by the expression and functionality of its lighting and accessories. With its warm materiality and modern expression, the Linear System Series brings feelings of home into larger spaces to give the user a sense of belonging, even if being there only for a little while. The extensive selection of lighting and accessories means that the Linear System Series can be configured and reshuffled for any purpose of the modern workplace as well as hospitality settings and public areas, arraying the ideas of aesthetic and function into one.”

— Thomas Bentzen



<b>Designed by</b>	Thomas Bentzen / 2020
<b>About the designer</b>	Thomas Bentzen, former Head of Design at Muuto, started his own studio in 2010. Bentzen’s designs are characterized by simplicity, rationality and functionality — always firmly rooted in the Danish design tradition, material knowledge, craftsmanship and rational industrial manufacturing processes. His work continues to receive international recognition at fairs and exhibitions all over the world.
<b>Environment</b>	Indoor
<b>Country of Production</b>	Latvia
<b>Preassembled</b>	No - Full assembly of chosen configuration is needed. Please see more information in the assembly instruction.
<b>Description</b>	<p>The Linear System Table is a simple yet refined table with subtle details and references to the Scandinavian design heritage. Its legs are cut into half-circles and joined with the table for a light expression while the slender overhang at both ends of the table makes for a refined expression.</p> <p>The Linear System Table is available as a freestanding table to be used on its own, as predesigned configurations or as Middle and End Modules that can be configured to the exact needs of your space.</p>
<b>Material</b>	<p>Tabletop in Oak Veneer, Black version in Ash Veneer, Black Nanolaminate or White Laminate. Black Nanolaminate and White Laminate has an ABS edge. It is not possible to mix multiple tabletop finishes in a Linear System configuration.</p> <p>Table frame in veneered plywood and legs in Solid Oak. Felt glides included.</p> <p>Oak Veneer color variations: The Oak Veneer tabletops of the Linear System Series are made using high-quality mix-matched veneer to avoid differences in the visual appearance from tabletop to tabletop. However, wood is a natural material, and this means that slight variations can occur from table to table.</p>

**MUUTO**

FOR PRODUCT INFORMATION, SWATCHES + ORDERING: [HELLO@RYPEN.COM](mailto:HELLO@RYPEN.COM) | 800.560.0554 | [WWW.RYPEN.COM](http://WWW.RYPEN.COM)

# Linear System Configurations



## Cleaning & Care

Wood and Veneer Surfaces: Clean the table with a damp cloth. If necessary only use a mild detergent or washing up liquid and not concentrated. Always wipe with a dry cloth afterwards. To minimize the risk of stains and marks, liquid, grease etc. should be removed straight away.

Laminate Surface: Clean the table with a damp cloth. If necessary use a mild detergent or washing up liquid and not concentrated. Always wipe with a dry cloth afterwards. To minimize the risk of stains and marks, liquids, grease etc. should be removed straight away.

Nano Laminate: Treat the surface with a melamine sponge, available in hardware stores, to reduce minor scratches.

## Options

Accessories: Optional Screens and Trays for the Linear System. Screens are available in three sizes to be used either freestanding or mounted. Trays in three different sizes, all to be mounted. We recommend that screens are mounted to the table. Both trays and screens must be placed at least 5 cm / 2" from the table edge. Lighting: Find more information in separate Product Fact Sheets. Table Power Outlet: Each Table Power Outlet has two standard power sockets and both one USB-A and a USB-C socket. Available in region-specific versions for EU and UK. Find more information in separate Product Fact Sheet. Power Kit: Integrated power for Mounted Lamp(s), Table Lamp(s) or Table Power Outlet(s). Available in region-specific versions for EU, UK and US. Wieland Power distribution block (5-way) and Wieland cables. Find more information in separate Product Fact Sheet. Cable Tray: Cables Tray to organize and hide cables under the table. Find more information in separate Product Fact Sheet.

# Linear System Configurations



## Dimensions

### Configuration 1

Length: 360 cm / 141.7"  
Height: 74 cm / 29.1"  
Width: 142 cm / 55.9"

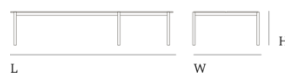

### Configuration 2

Length: 480 cm / 189"  
Height: 74 cm / 29.1"  
Width: 142 cm / 55.9"



### Configuration 3

Length: 720 cm / 283.5"  
Height: 74 cm / 29.1"  
Width: 142 cm / 55.9"



## Ready-to-ship

Black Nanolaminate/Black ABS/Black  
Black Lacquered Ash Veneer/Black  
White Laminate/White ABS/Oak  
Black Nanolaminate/Black ABS/Oak  
Oak Veneer/Oak



## Tests, Labels & Certifications

Strength, Durability & Stability

EN 15372-L2 & -L3 Furniture

Note that the connector pins in this product contains lead, CAS no. 7439-92-1.

# LINEAR SYSTEM SERIES—ORDER GUIDE



The Linear System Series brings a new perspective to the evolving needs of the modern workspaces, hospitality settings and educational institutions through its configurable design across tables, lighting, screens and trays alongside its custom integrated power solution, allowing one to tailor the design to the exact needs of any space.

**Option A** — Choose between one of our predesigned table configurations and simply add your desired lamps and accessories.

**Option B** — Create your own configuration from scratch and add lamps and accessories from there. [Scroll down 6 pages.](#)

## Option A — Predesigned Table Configurations

### STEP 1. TABLES

Select either the Linear System Table or one of three Linear System Table Configurations.

#### Linear System Table

Height — 74 cm / 29.1"  
Table top width — 142 cm / 55.9"  
Total width — 146.9 cm / 57.8"  
Total length — 240 cm / 94.5"  
No of Persons — 4-6

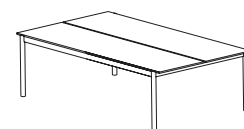

240 cm / 94.5"

#### Linear System Table Configuration 1

Height — 74 cm / 29.1"  
Table top width — 142 cm / 55.9"  
Total width — 146.9 cm / 57.8"  
Total length — 360 cm / 141.7"  
No of Persons — 6-8

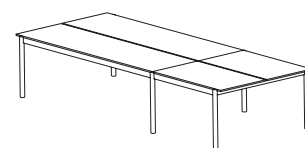

240 cm / 94.5"    120 cm / 47.2"

#### Linear System Table Configuration 2

Height — 74 cm / 29.1"  
Table top width — 142 cm / 55.9"  
Total width — 146.9 cm / 57.8"  
Total length — 480 cm / 189"  
No of Persons — 8-12

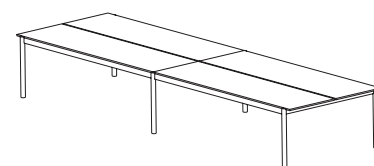

240 cm / 94.5"    240 cm / 94.5"

#### Linear System Table Configuration 3

Height — 74 cm / 29.1"  
Table top width — 142 cm / 55.9"  
Total width — 146.9 cm / 57.8"  
Total length — 720 cm / 283.5"  
No of Persons — 12-18

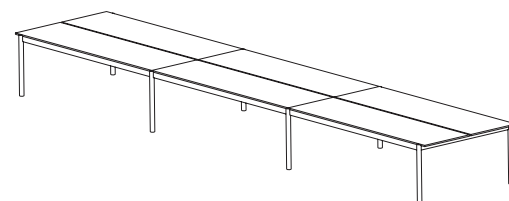

240 cm / 94.5"    240 cm / 94.5"    240 cm / 94.5"

### OPTION A

[1. TABLES](#) / [2. ACCESSORIES](#) / [3. LIGHTING](#) / [4. TABLE POWER OUTLET](#) / [5. INTEGRATED POWER](#) / [6. CABLE TRAY](#)

**MUUTO**

FOR PRODUCT INFORMATION, SWATCHES + ORDERING: [HELLO@RYPEN.COM](mailto:HELLO@RYPEN.COM) | 800.560.0554 | [WWW.RYPEN.COM](http://WWW.RYPEN.COM)

# LINEAR SYSTEM SERIES—ORDER GUIDE



## STEP 2. ACCESSORIES

### Trays

Add your desired number of Linear System Trays.

**Note**  
Trays must be mounted at least 5 cm / 2" from the table edge.

### Linear System Tray — Ø24 cm / 9.5"

Height — 15,6 cm / 6.2"  
Diameter — 24 cm / 9.5"



### Linear System Tray — Ø36 cm / 14.2"

Height — 9,6 cm / 3.8"  
Diameter — 36 cm / 14.2"



### Linear System Tray — 170 cm / 66.9"

Height — 15 cm / 5.9"  
Width — 21 cm / 8.3"  
Length — 170 cm / 66.9"

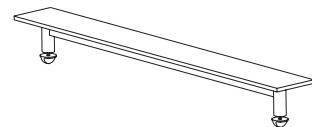

### Screens

Add your desired number of Linear System Screens.

**Note**  
We recommend that screens are mounted to the table. They must be placed at least 5 cm / 2" from the table edge.

### Linear System Screen — 75 cm / 29.5"

Height — 35 cm / 13.8"  
Width — 15 cm / 5.9"  
Length — 75 cm / 29.5"

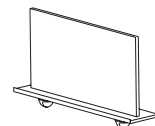

### Linear System Screen — 125 cm / 49.2"

Height — 35 cm / 13.8"  
Width — 15 cm / 5.9"  
Length — 125 cm / 49.2"

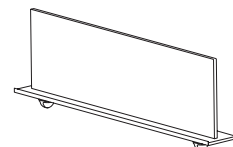

### Linear System Screen — 178 cm / 70.1"

Height — 35 cm / 13.8"  
Width — 15 cm / 5.9"  
Length — 178 cm / 70.1"

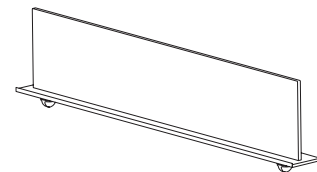

**Note**  
Please note that only the Linear System Screen 125 cm / 49.2" can be mounted across the table.

### Example

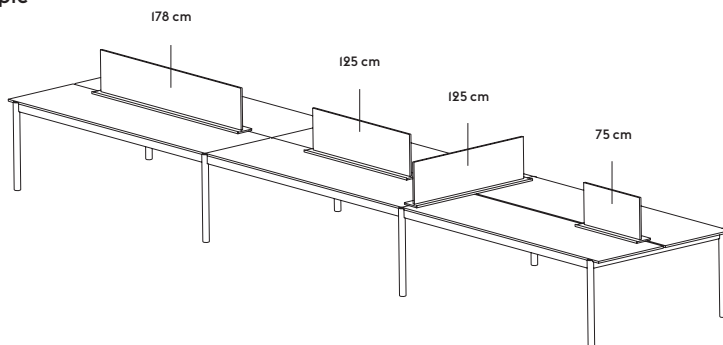

### OPTION A

1. TABLES / 2. ACCESSORIES / 3. LIGHTING / 4. TABLE POWER OUTLET / 5. INTEGRATED POWER / 6. CABLE TRAY

**MUUTO**

FOR PRODUCT INFORMATION, SWATCHES + ORDERING: [HELLO@RYPEN.COM](mailto:HELLO@RYPEN.COM) | 800.560.0554 | [WWW.RYPEN.COM](http://WWW.RYPEN.COM)

# LINEAR SYSTEM SERIES—ORDER GUIDE



## STEP 3. LIGHTING

Add your desired number of Linear Lamps.

**Note**  
The Linear Table Lamp has one USB-C plug.

### Linear Table Lamp

Height — 36,5 cm / 14.4"  
Width — 23,2 cm / 9.1"  
Depth — 16,5 cm / 6.5"



**Note**  
Linear Mounted Lamp must be mounted at least 5 cm / 2" from the table edge.

Please be aware that the Linear Mounted Lamp and Table Power Outlet, both designed for the Linear System Series, have a special power solution with special plugs.

### Linear Mounted Lamp — 23,2 cm / 9.1"

Height — 36,5 cm / 14.4"  
Width — 23,2 cm / 9.1"  
Depth — 10,7 cm / 4.2"

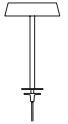

### Linear Mounted Lamp — 209,2 cm / 82.4"

Height — 70,7 cm / 27.8"  
Width — 209,2 cm / 82.4"  
Depth — 10,7 cm / 4.2"



## STEP 4. TABLE POWER OUTLETS

Specify your desired number of Table Power Outlets. Each Table Power Outlet has two outlets (one at each end) and one USB-A and USB-C plug to which standard plugs can be connected.

**Note**  
Linear System Table Power Outlet must be mounted at least 5 cm / 2" from the table edge.

### Linear System Table Power Outlet — US

Height — 7 cm / 2.8"  
Width — 7 cm / 2.8"  
Length — 18 cm / 7.1"

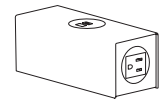

(US)

## OPTION A

1. TABLES / 2. ACCESSORIES / 3. LIGHTING / 4. TABLE POWER OUTLET / 5. INTEGRATED POWER / 6. CABLE TRAY

**MUUTO**

FOR PRODUCT INFORMATION, SWATCHES + ORDERING: [HELLO@RYPEN.COM](mailto:HELLO@RYPEN.COM) | 800.560.0554 | [WWW.RYPEN.COM](http://WWW.RYPEN.COM)

# LINEAR SYSTEM SERIES—ORDER GUIDE



## STEP 5. INTEGRATED POWER FOR MOUNTED LAMPS & TABLE POWER OUTLETS

If you'd like to add the Mounted Lamp(s) or Table Power Outlet(s), select the Table Power Kit for the Linear System Table or one of the three Power Configurations that match your selected Linear System Table Configuration.

**Note**  
Each Distribution Block has four outlets to which up to four Linear Mounted Lamps or Linear System Table Power Outlets can be plugged in.

Distribution Block — 4-way

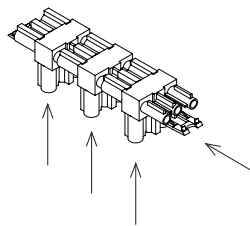

US cable  
500 cm / 197" cable

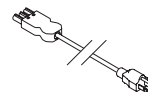

### Linear System Table

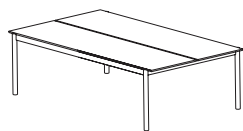

### Linear System Power

Power Kit (1 pcs)  
500 cm / 197" cable (US)  
Distribution Block

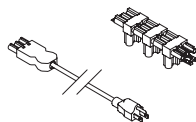

### Linear System Table Configuration 1

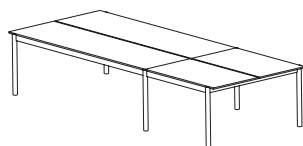

### Linear System Power Configuration 1

Power Kit (1 pcs)  
500 cm / 197" cable (US)  
Distribution Block

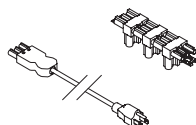

### Linear System Table Configuration 2

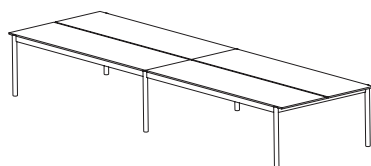

### Linear System Power Configuration 2

Power Kit (1 pcs)  
500 cm / 197" cable (US)  
Distribution Block

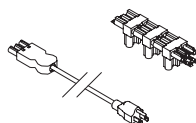

Power Kit (1 pcs)  
500 cm / 197" cable (US)  
Distribution Block

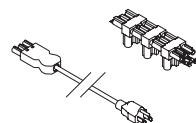

+

### Linear System Table Configuration 3

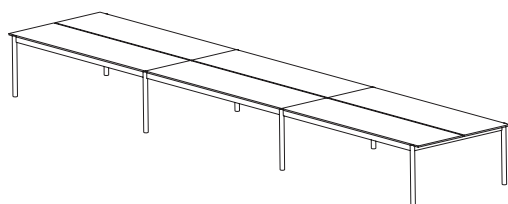

### Linear System Power Configuration 3

Power Kit (1 pcs)  
500 cm / 197" cable (US)  
Distribution Block

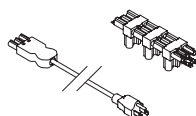

Power Kit (1 pcs)  
500 cm / 197" cable (US)  
Distribution Block

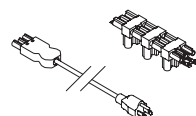

Power Kit (1 pcs)  
500 cm / 197" cable (US)  
Distribution Block

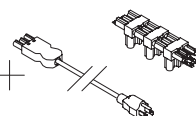

+

OPTION A  
1. TABLES / 2. ACCESSORIES / 3. LIGHTING / 4. TABLE POWER OUTLET / 5. INTEGRATED POWER / 6. CABLE TRAY

**MUUTO**

FOR PRODUCT INFORMATION, SWATCHES + ORDERING: [HELLO@RYPEN.COM](mailto:HELLO@RYPEN.COM) | 800.560.0554 | [WWW.RYPEN.COM](http://WWW.RYPEN.COM)

# LINEAR SYSTEM SERIES—ORDER GUIDE



**Note**  
The Integrated Power for Linear System Series has unique internal plugs to provide a slim and discreet look. This means that you cannot connect a standard plug to the power without using the Linear Table Power Outlet or changing the standard plug to a matching plug, being the Wieland GSTI8I3 plug.

The Linear Mounted Lamps must be connected to the integrated Power Kit.

Wieland GSTI8I3 plug

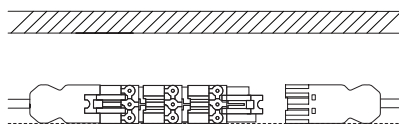

Standard plug (US)

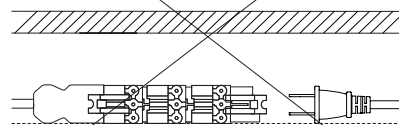

1. Connecting using the Wieland GSTI8I3 plug

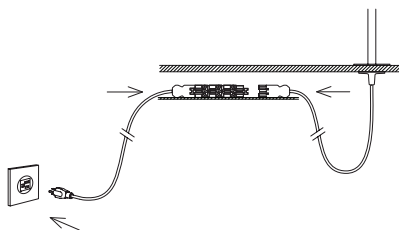

2. Connecting using a standard plug to the Linear Table Power Outlet

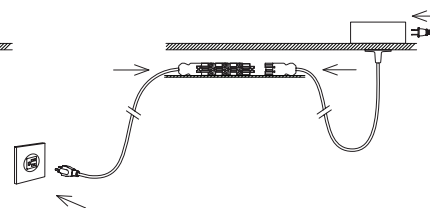

## LINEAR TABLE LAMP ONLY

The Linear Table Lamp can either be connected to a standard wall plug or the Table Power Outlet.

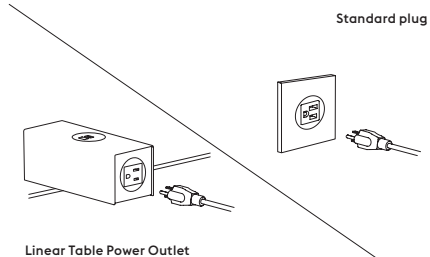
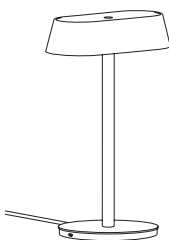

Alternatively, you can connect it to the integrated Power Kit by replacing the plug with a custom Wieland GSTI8I3 plug that is included with the lamp. Kindly refer to the Linear Table Lamp manual for instructions.

Integrated Table Power Kit (Wieland GSTI8I3 plug)

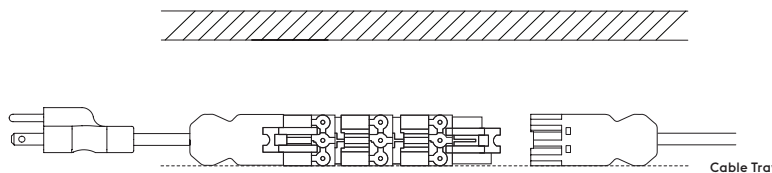

### OPTION A

1. TABLES / 2. ACCESSORIES / 3. LIGHTING / 4. TABLE POWER OUTLET / 5. INTEGRATED POWER / 6. CABLE TRAY







## STEP 6. CABLE TRAYS

We recommend using 1 Cable Tray for the End Module – 120 cm / 47.2" and up to 3 Cable Trays for the Linear Table, End Module – 240 cm / 94.2" and the Middle Module – 240 cm / 94.2".

### Linear System Cable Tray

Height – 3 cm / 1.2"  
Width – 22 cm / 8.7"  
Depth – 60 cm / 23.7"

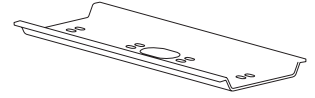

### Example:

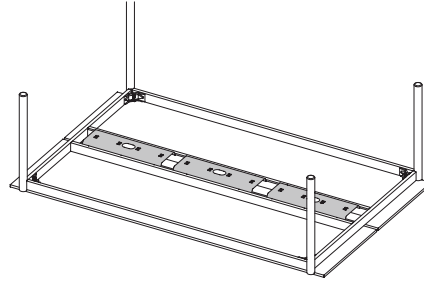

Linear System Table – 240 cm / 94.5"

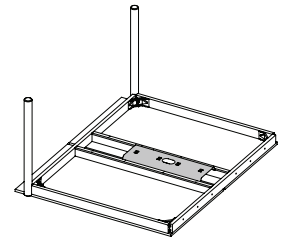

Linear System End Module – 120 cm / 47.2"

OPTION A

1. TABLES / 2. ACCESSORIES / 3. LIGHTING / 4. TABLE POWER OUTLET / 5. INTEGRATED POWER / 6. CABLE TRAY

**MUUTO**



## Option B — Create your own configuration

### STEP 1. TABLES

#### A)

A configuration must always have End Modules in each end.

Start by defining the total length of your desired configuration, then select two table ends.

#### Linear System End Module — 240 cm / 94.5"

Height — 74 cm / 29.1"  
 Width — 146,9 cm / 57.8"  
 Length — 240 cm / 94.5"  
 No of Persons — 4-6



#### Linear System End Module — 120 cm / 47.2"

Height — 74 cm / 29.1"  
 Width — 146,9 cm / 57.8"  
 Length — 120 cm / 47.2"  
 No of Persons — 2



#### B)

Next, add the second, and final, End Module or your desired number of Middle Modules, only available in 240 cm / 94.5".

**Note**  
 Please note that it is not possible to connect more than two End Modules.

#### Linear System Middle Module — 240 cm / 94.5"

Width — 146,9 cm / 57.8"  
 Length — 240 cm / 94.5"  
 No of Persons — 4-6



#### C)

Next, you must order 1 set of Connecting Legs every time two modules are connected.

#### Linear System Connecting Legs

Height — 74 cm / 29.1"

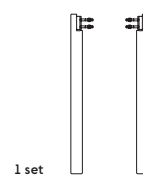

If you'd like a configuration of one End Module — 240 cm / 94.5" and one Middle Module — 240 cm / 94.5" and one End Module — 240 cm / 94.5", you must order two sets of Connecting Legs, as shown in the illustration.

#### Example

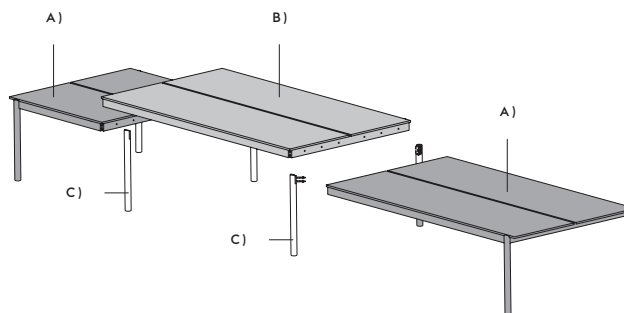

OPTION B  
 1. TABLES / 2. ACCESSORIES / 3. LIGHTING / 4. TABLE POWER OUTLET / 5. INTEGRATED POWER / 6. CABLE TRAY



# LINEAR SYSTEM SERIES—ORDER GUIDE



## STEP 2. ACCESSORIES

### Trays

Add your desired number of Linear System Trays.

**Note**  
Trays must be mounted at least 5 cm / 2" from the table edge.

#### Linear System Tray — Ø24 cm / 9.5"

Height — 15,6 cm / 6.2"  
Diameter — 24 cm / 9.5"



#### Linear System Tray — Ø36 cm / 14.2"

Height — 9,6 cm / 3.8"  
Diameter — 36 cm / 14.2"



#### Linear System Tray — 170 cm / 66.9"

Height — 15 cm / 5.9"  
Width — 21 cm / 8.3"  
Length — 170 cm / 66.9"

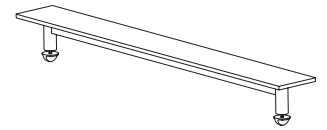

### Screens

Add your desired number of Linear System Screens.

**Note**  
We recommend that screens are mounted to the table. They must be placed at least 5 cm / 2" from the table edge.

#### Linear System Screen — 75 cm / 29.5"

Height — 35 cm / 13.8"  
Width — 15 cm / 5.9"  
Length — 75 cm / 29.5"

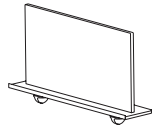

#### Linear System Screen — 125 cm / 49.2"

Height — 35 cm / 13.8"  
Width — 15 cm / 5.9"  
Length — 125 cm / 49.2"

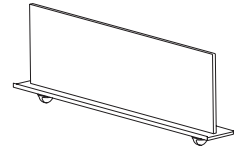

#### Linear System Screen — 178 cm / 70.1"

Height — 35 cm / 13.8"  
Width — 15 cm / 5.9"  
Length — 178 cm / 70.1"

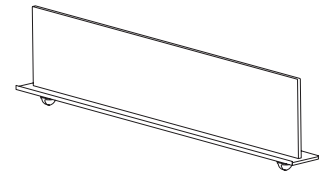

**Note**  
Please note that only the Linear System Screen 125 cm / 49.2" can be mounted across the table.

### Example

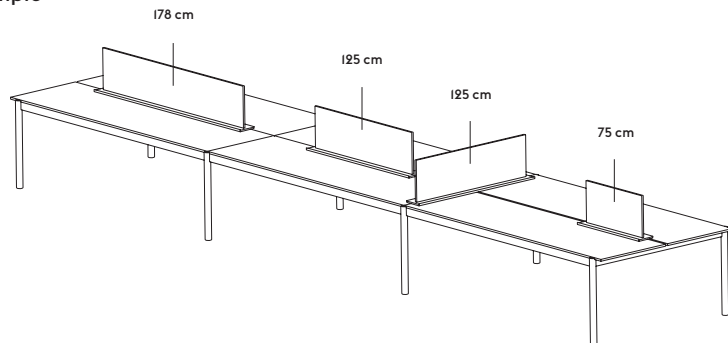

### OPTION B

1. TABLES / 2. ACCESSORIES / 3. LIGHTING / 4. TABLE POWER OUTLET / 5. INTEGRATED POWER / 6. CABLE TRAY

**MUUTO**

FOR PRODUCT INFORMATION, SWATCHES + ORDERING: [HELLO@RYPEN.COM](mailto:HELLO@RYPEN.COM) | 800.560.0554 | [WWW.RYPEN.COM](http://WWW.RYPEN.COM)

# LINEAR SYSTEM SERIES—ORDER GUIDE



## STEP 3. LIGHTING

Add your desired number of Linear Lamps.

**Note**  
The Linear Table Lamp has one USB-C plug.

### Linear Table Lamp

Height — 36,5 cm / 14.4"  
Width — 23,2 cm / 9.1"  
Depth — 16,5 cm / 6.5"



**Note**  
Linear Mounted Lamp must be mounted at least 5 cm / 2" from the table edge.

Please be aware that the Linear Mounted Lamp and Table Power Outlet, both designed for the Linear System Series, have a special power solution with special plugs.

### Linear Mounted Lamp — 23,2 cm / 9.1"

Height — 36,5 cm / 14.4"  
Width — 23,2 cm / 9.1"  
Depth — 10,7 cm / 4.2"

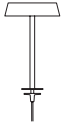

### Linear Mounted Lamp — 209,2 cm / 82.4"

Height — 70,7 cm / 27.8"  
Width — 209,2 cm / 82.4"  
Depth — 10,7 cm / 4.2"



## STEP 4. TABLE POWER OUTLETS

Specify your desired number of Table Power Outlets. Each Table Power Outlet has two outlets (one at each end) and one USB-A and USB-C plug to which standard plugs can be connected.

**Note**  
Linear System Table Power Outlet must be mounted at least 5 cm / 2" from the table edge.

### Linear System Table Power Outlet — US

Height — 7 cm / 2.8"  
Width — 7 cm / 2.8"  
Length — 18 cm / 7.1"

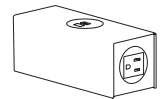

(US)

## OPTION B

1. TABLES / 2. ACCESSORIES / 3. LIGHTING / 4. TABLE POWER OUTLET / 5. INTEGRATED POWER / 6. CABLE TRAY

**MUUTO**

FOR PRODUCT INFORMATION, SWATCHES + ORDERING: [HELLO@RYPEN.COM](mailto:HELLO@RYPEN.COM) | 800.560.0554 | [WWW.RYPEN.COM](http://WWW.RYPEN.COM)

# LINEAR SYSTEM SERIES—ORDER GUIDE



## STEP 5. INTEGRATED POWER FOR MOUNTED LAMPS & TABLE POWER OUTLET

If you'd like to add the Mounted Lamp(s) and/or Table Power Outlets, select the Power Kit.

If you add a End Module or a Middle Module — 240 cm / 94.5" add a Power Kit for each table added.

### Power Kit (1 pcs)

500 cm / 197" cable (US)  
Distribution Block

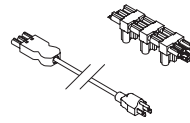

### Example 1

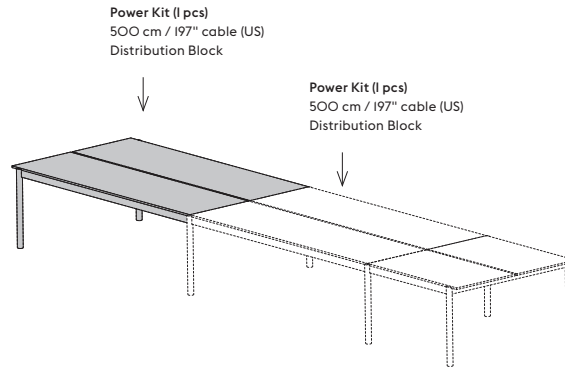

### Example 2

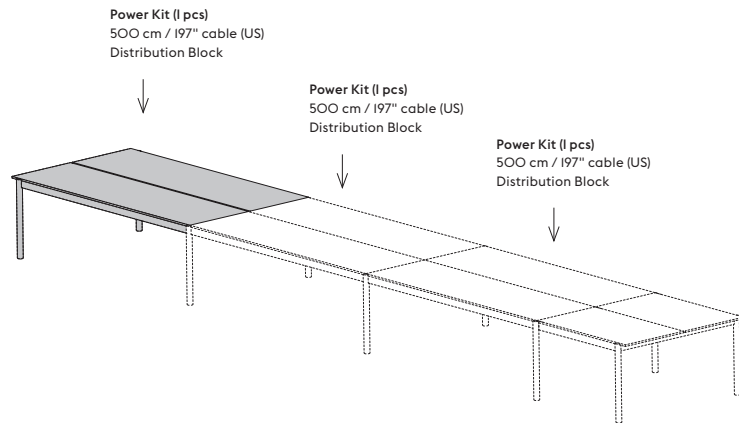

#### OPTION B

1. TABLES / 2. ACCESSORIES / 3. LIGHTING / 4. TABLE POWER OUTLET / 5. INTEGRATED POWER / 6. CABLE TRAY

**MUUTO**

FOR PRODUCT INFORMATION, SWATCHES + ORDERING: [HELLO@RYPEN.COM](mailto:HELLO@RYPEN.COM) | 800.560.0554 | [WWW.RYPEN.COM](http://WWW.RYPEN.COM)

# LINEAR SYSTEM SERIES—ORDER GUIDE



## LINEAR TABLE LAMP ONLY

The Linear Table Lamp can either be connected to a standard wall plug or the Table Power Outlet.

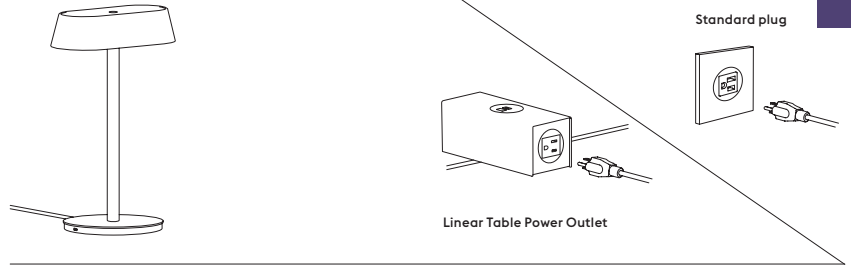

Alternatively, you can connect it to the integrated Table Power Kit by replacing the plug with a custom Wieland GSTI813 plug that is included with the lamp. Kindly refer to the Linear Table Lamp manual for instructions.

Integrated Table Power Kit (Wieland GSTI813 plug)

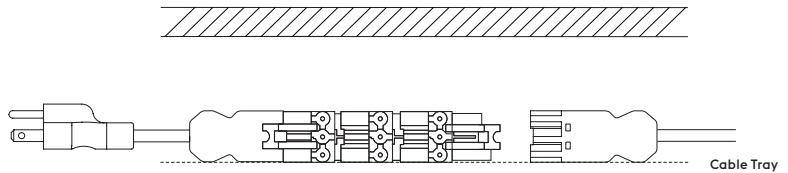

## STEP 6. CABLE TRAYS

We recommend using 1 Cable Tray for the End Module – 120 cm / 47.2" and up to 3 Cable Trays for the Linear Table, End Module – 240 cm / 94.2" and the Middle Module – 240 cm / 94.2".

### Linear System Cable Tray

Height – 3 cm / 1.2"  
Width – 22 cm / 8.7"  
Depth – 60 cm / 23.7"

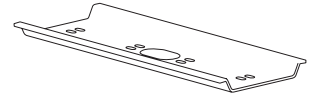

### Example:

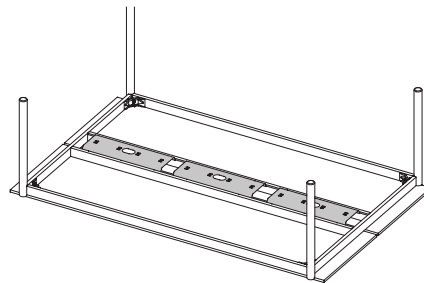

Linear System Table – 240 cm / 94.5"

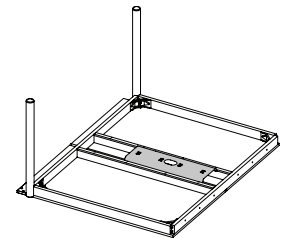

Linear System End Module – 120 cm / 47.2"

### OPTION B

1. TABLES / 2. ACCESSORIES / 3. LIGHTING / 4. TABLE POWER OUTLET / 5. INTEGRATED POWER / 6. CABLE TRAY



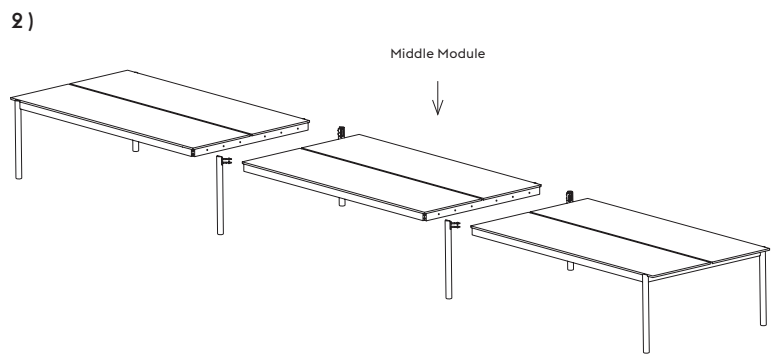
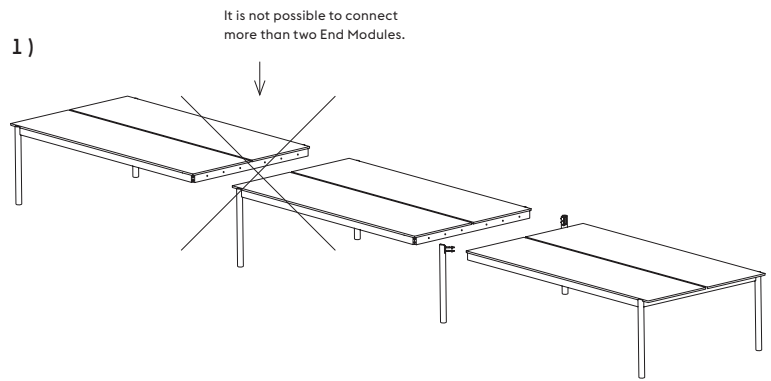

**MUUTO**

# Linear System Tray

“The Linear System Series places people at its center, being a place to meet, to collaborate or to work in focused solitude. The design process was about creating a system that made for intimately welcoming atmospheres, enhanced by the expression and functionality of its lighting and accessories. With its warm materiality and modern expression, the Linear System Series brings feelings of home into larger spaces to give the user a sense of belonging, even if being there only for a little while. The extensive selection of lighting and accessories means that the Linear System Series can be configured and reshuffled for any purpose of the modern workplace as well as hospitality settings and public areas, arraying the ideas of aesthetic and function into one.”

— Thomas Bentzen



<b>Designed by</b>	Thomas Bentzen / 2020
<b>About the designer</b>	Thomas Bentzen, former Head of Design at Muuto, started his own studio in 2010. Bentzen's designs are characterized by simplicity, rationality and functionality — always firmly rooted in the Danish design tradition, material knowledge, craftsmanship and rational industrial manufacturing processes. His work continues to receive international recognition at fairs and exhibitions all over the world.
<b>Environment</b>	Indoor
<b>Country of Production</b>	Latvia
<b>Preassembled</b>	Yes - Mount to configuration.
<b>Description</b>	Designed as part of the Linear System Series, the Linear System Tray has an inviting look that makes its user gravitate intuitively towards it. Use the trays to create smaller spaces within the larger settings while allowing for objects to be stored on their plateau alongside the warmth of its oak that translates sentiments of home into any setting.  Kindly note that the Linear System Tray must be mounted onto the Linear System Series design.
<b>Material</b>	Tray 170 cm in solid oak and oak veneer. Tray Ø24 and Ø36 in solid oak. All with powder coated aluminum fixing knobs.
<b>Cleaning &amp; Care</b>	Clean the tray with a damp cloth. If necessary only use a mild detergent or washing up liquid and not concentrated. Always wipe with a dry cloth afterwards. To minimize the risk of stains and marks, liquid, grease etc. should be removed straight away.

**MUUTO**



# Linear System Tray



## Dimensions

### 170 cm / 66.9"

Length: 170 cm / 66.9"  
Height: 15 cm / 5.9"  
Width: 21 cm / 8.3"



### Ø 24 cm / 9.4"

Length: 24 cm / 9.4"  
Height: 15.6 cm / 6.2"  
Width: 24 cm / 9.4"

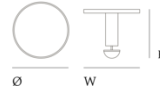

### Ø 36 cm / 14.2"

Length: 36 cm / 14.2"  
Height: 9.6 cm / 3.8"  
Width: 36 cm / 14.2"

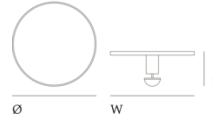

## Ready-to-ship

Oak  
Black



## Tests, Labels & Certifications

**Eco-Labels & Certificates** VOC — Bifma X 7.1  
VOC — CDPH 01350

**Strength, Durability & Stability** EN 15372-L2 & -L3 Furniture

# Linear System Screen

“The Linear System Series places people at its center, being a place to meet, to collaborate or to work in focused solitude. The design process was about creating a system that made for intimately welcoming atmospheres, enhanced by the expression and functionality of its lighting and accessories. With its warm materiality and modern expression, the Linear System Series brings feelings of home into larger spaces to give the user a sense of belonging, even if being there only for a little while. The extensive selection of lighting and accessories means that the Linear System Series can be configured and reshuffled for any purpose of the modern workplace as well as hospitality settings and public areas, arraying the ideas of aesthetic and function into one.”

— Thomas Bentzen



<b>Designed by</b>	Thomas Bentzen / 2020
<b>About the designer</b>	Thomas Bentzen, former Head of Design at Muuto, started his own studio in 2010. Bentzen's designs are characterized by simplicity, rationality and functionality — always firmly rooted in the Danish design tradition, material knowledge, craftsmanship and rational industrial manufacturing processes. His work continues to receive international recognition at fairs and exhibitions all over the world.
<b>Environment</b>	Indoor
<b>Country of Production</b>	Latvia
<b>Preassembled</b>	Yes - Mount to configuration.
<b>Description</b>	The Linear System Screen creates intimate atmospheres without shielding one from the outside world alongside the subtle functionality of its integrated feet on both sides for storing smaller objects. Can be used either freestanding or mounted onto the Linear System Series.
<b>Material</b>	Screens are in solid oak and veneered MDF with powder coated aluminum fixing knobs. Possibility of upholstery on Screens.
<b>Cleaning &amp; Care</b>	Wooden surface: Clean with a damp cloth. If necessary, only use a mild detergent or washing up liquid and not concentrated. Always wipe with a dry cloth afterwards. To minimize the risk of stains and marks, liquid, grease etc. should be removed straight away.  Textile: Remove non-greasy stains by carefully dabbing with a lint-free cloth wrung out in clean, warm water. If necessary, clean by dabbing with soapy water. Visit <a href="http://Kvadrat.dk">Kvadrat.dk</a> for further information on cleaning textiles.

**MUUTO**

FOR PRODUCT INFORMATION, SWATCHES + ORDERING: [HELLO@RYPEN.COM](mailto:HELLO@RYPEN.COM) | 800.560.0554 | [WWW.RYPEN.COM](http://WWW.RYPEN.COM)

# Linear System Screen



## Dimensions

### 125 cm / 49.2"

Length: 125 cm / 49.2"  
Height: 35 cm / 13.8"  
Width: 15 cm / 5.9"



### 178 cm / 70.1"

Length: 178 cm / 70.1"  
Height: 35 cm / 13.8"  
Width: 15 cm / 5.9"



### 75 cm / 29.5"

Length: 75 cm / 29.5"  
Height: 35 cm / 13.8"  
Width: 15 cm / 5.9"

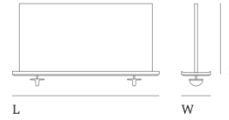

## Ready-to-ship

Oak  
Black



## Made-to-order

This product can be upholstered in the following textiles: Canvas, Clara, Divina, Divina MD, Divina Melange, Fiord, Hallingdal, Hero, Ocean, Planum, Remix, Re-wool, Sabi, Steelcut, Steelcut Trio, Twill Weave, Wooly

## Tests, Labels & Certifications

**Eco-Labels & Certificates** VOC — Bifma X 7.1  
VOC — CDPH 01350

**Strength, Durability & Stability** EN 15372-L2 & -L3 Furniture

# Linear Table Lamp

“The Linear Lamp Series is designed from the idea of creating smaller atmospheres through modern light, bringing a sense of intimacy to larger spaces. With their elegant expression, subtle details and inherent functionality of a dimmable light source, the designs create space for both being and working on your own as well as making for a friendly environment when in the company of others. Use the Linear Lamp Series for any space in need of modern, functional lighting that can be adjusted to the exact purpose of your space.”

— Thomas Bentzen



<b>Designed by</b>	Thomas Bentzen / 2020
<b>About the designer</b>	Thomas Bentzen, former Head of Design at Muuto, started his own studio in 2010. Bentzen's designs are characterized by simplicity, rationality and functionality — always firmly rooted in the Danish design tradition, material knowledge, craftsmanship and rational industrial manufacturing processes. His work continues to receive international recognition at fairs and exhibitions all over the world.
<b>Environment</b>	Indoor And Outdoor
<b>Country of Production</b>	China
<b>Preassembled</b>	Yes.
<b>Description</b>	The Linear Table Lamp brings an elegant expression and subtle details to any space. Designed with inherent functionality through its dimmable light source, the Linear Table Lamp hints towards the archetypal library lamp through its familiar form, joined by a friendly character that allows for it to be used in any setting. The design features a USB-C plug for charging electronic devices.
<b>Material</b>	Lamphead in pressure-die casted, powder coated aluminum. Stem in powder coated steel. Polycarbonate diffuser and PVC cord.
<b>Cleaning &amp; Care</b>	Clean with soft dry cloth only. Always switch off the electricity supply before cleaning.
<b>Light source included</b>	Yes.
<b>Dimmable function</b>	Yes.

**MUUTO**

FOR PRODUCT INFORMATION, SWATCHES + ORDERING: [HELLO@RYPEN.COM](mailto:HELLO@RYPEN.COM) | 800.560.0554 | [WWW.RYPEN.COM](http://WWW.RYPEN.COM)

# Linear Table Lamp



## Dimensions

Length: 23,2 cm / 9.1"  
Height: 36,5 cm / 14.4"  
Width: 16,5 cm / 6.5"



## Ready-to-ship

Black  
Grey



## Lamp rating

Voltage 120V  
Frequency 60Hz  
IP Rating IP20  
Socket Integrated, non-replaceable LEDs

## Light source specification

Item 1 x Integrated, non-replaceable LED  
Watt 6,25W  
Lumen 242 lm  
Lumen Maintenance 48.000h  
Kelvin 3.000K  
CRI 90  
Dimmable Yes  
Risk Group Except

## Tests, Labels & Certifications

Safety & Regulations cETLus or cULus



**MUUTO**

# Linear Mounted Lamp

“The Linear Lamp Series is designed from the idea of creating smaller atmospheres through modern light, bringing a sense of intimacy to larger spaces. With their elegant expression, subtle details and inherent functionality of a dimmable light source, the designs create space for both being and working on your own as well as making for a friendly environment when in the company of others. Use the Linear Lamp Series for any space in need of modern, functional lighting that can be adjusted to the exact purpose of your space.”

— Thomas Bentzen

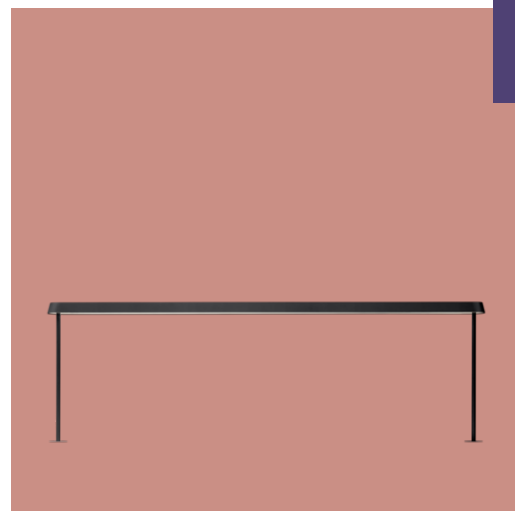

<b>Designed by</b>	Thomas Bentzen / 2020
<b>About the designer</b>	Thomas Bentzen, former Head of Design at Muuto, started his own studio in 2010. Bentzen’s designs are characterized by simplicity, rationality and functionality — always firmly rooted in the Danish design tradition, material knowledge, craftsmanship and rational industrial manufacturing processes. His work continues to receive international recognition at fairs and exhibitions all over the world.
<b>Environment</b>	Indoor
<b>Country of Production</b>	China
<b>Preassembled</b>	Yes.
<b>Description</b>	The Linear Mounted Lamp brings an elegant expression and subtle details to any space. Designed with inherent functionality through its dimmable light source, the Linear Table Lamp hints towards the archetypal library lamp through its familiar form, joined by a friendly character that allows for it to be used in any setting.  Note that the Linear Mounted Lamp must be used on either of the Linear System Table designs.
<b>Material</b>	Lamphead is made in pressure-die casted, powder coated aluminum. Stem in powder coated steel. Polycarbonate diffuser and PVC cord with GST1813 plug.
<b>Cleaning &amp; Care</b>	Clean with soft dry cloth only. Always switch off electricity supply before cleaning.
<b>Light source included</b>	82.4", 9.1": Yes
<b>Dimmable function</b>	Yes.
<b>Table Power Kit</b>	Integrated power available in region-specific versions for EU, UK & US. Wieland Power distribution block (5-way) and Wieland cables.

**MUUTO**

# Linear Mounted Lamp



## Dimensions

**82.4"**  
Length: 209,2 cm / 82.4"  
Height: 70,7 cm / 27.8"  
Width: 10,7 cm / 4.2"



**9.1"**  
Length: 23,2 cm / 9.1"  
Height: 36,5 cm / 14.4"  
Width: 10,7 cm / 4.2"



## Ready-to-ship

Black  
Grey



## Lamp rating

	82.4"	9.1"
Voltage	120V	120V
Frequency	60Hz	60Hz
IP Rating	IP20	IP20
Socket	Integrated, non-replaceable LEDs	Integrated, non-replaceable LEDs

## Light source specification

Item	82.4"	9.1"
Item	1 x Integrated, non-replaceable LED	1 x Integrated, non-replaceable LED
Watt	58,9W	6,25W
Lumen	2700 lm	242 lm
Lumen Maintenance	48.000h	48.000h
Kelvin	3.000K	3.000K
CRI	90	90
Dimmable	Yes	Yes
Risk Group	Except	Except

## Tests, Labels & Certifications

Safety & Regulations cETLus or cULus



# Linear System Table Power Outlet

“The Linear System Series places people at its center, being a place to meet, to collaborate or to work in focused solitude. The design process was about creating a system that made for intimately welcoming atmospheres, enhanced by the expression and functionality of its lighting and accessories. With its warm materiality and modern expression, the Linear System Series brings feelings of home into larger spaces to give the user a sense of belonging, even if being there only for a little while. The extensive selection of lighting and accessories means that the Linear System Series can be configured and reshuffled for any purpose of the modern workplace as well as hospitality settings and public areas, arraying the ideas of aesthetic and function into one.”

— Thomas Bentzen



<b>Designed by</b>	Thomas Bentzen / 2020
<b>About the designer</b>	Thomas Bentzen, former Head of Design at Muuto, started his own studio in 2010. Bentzen’s designs are characterized by simplicity, rationality and functionality — always firmly rooted in the Danish design tradition, material knowledge, craftsmanship and rational industrial manufacturing processes. His work continues to receive international recognition at fairs and exhibitions all over the world.
<b>Environment</b>	Indoor
<b>Country of Production</b>	UK
<b>Preassembled</b>	Yes.
<b>Description</b>	<p>The Linear System Table Power Outlet is simple in its design and functionality: You simply plug in and go from there. The elements are designed in lines that echo the Linear System Series, made in sheet metal for an elegant touch.</p> <p>The Table Power Outlet can be mounted on the Linear System Table and has two outlets to which standard plugs can be connected as well as a USB plug.</p>
<b>Material</b>	Base in powder coated sheet metal. Threaded pin in galvanized steel. Fascias in polycarbonate. Cord in PVC with GST1813 plug.
<b>Cleaning &amp; Care</b>	Remove dust from the power outlet with a soft cloth.

**MUUTO**



# Linear System Table Power Outlet



## Dimensions

Length: 18 cm / 7.1"  
Height: 7 cm / 2.8"  
Width: 7 cm / 2.8"

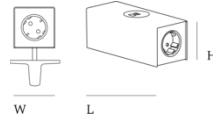

## Ready-to-ship

Black  
Grey



# Linear System Cable Tray

“The Linear System Series places people at its center, being a place to meet, to collaborate or to work in focused solitude. The design process was about creating a system that made for intimately welcoming atmospheres, enhanced by the expression and functionality of its lighting and accessories. With its warm materiality and modern expression, the Linear System Series brings feelings of home into larger spaces to give the user a sense of belonging, even if being there only for a little while. The extensive selection of lighting and accessories means that the Linear System Series can be configured and reshuffled for any purpose of the modern workplace as well as hospitality settings and public areas, arraying the ideas of aesthetic and function into one.”

— Thomas Bentzen



<b>Designed by</b>	Thomas Bentzen / 2020
<b>About the designer</b>	Thomas Bentzen, former Head of Design at Muuto, started his own studio in 2010. Bentzen's designs are characterized by simplicity, rationality and functionality — always firmly rooted in the Danish design tradition, material knowledge, craftsmanship and rational industrial manufacturing processes. His work continues to receive international recognition at fairs and exhibitions all over the world.
<b>Environment</b>	Indoor
<b>Country of Production</b>	Germany
<b>Preassembled</b>	Yes - Mount to configuration.
<b>Description</b>	A Cable Tray to be used for the Linear System Series.
<b>Material</b>	Made in form-pressed PET felt.
<b>Cleaning &amp; Care</b>	Wipe off dust with dry cloth. If necessary use a moist cloth, then dry off.

**MUUTO**

# Linear System Cable Tray



## Dimensions

Length: 60 cm / 23.7"  
Height: 3 cm / 1.2"  
Width: 22 cm / 8.7"

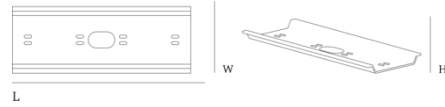

---

## Ready-to-ship

Dark Grey





PROFESSIONALS

**rypen**  
STUDIO

Register for Our Exclusive  
Project Builder + Ordering Platform

**MUUTO**